

MODEL:
M92

DISTRIBUTION MANIFOLD

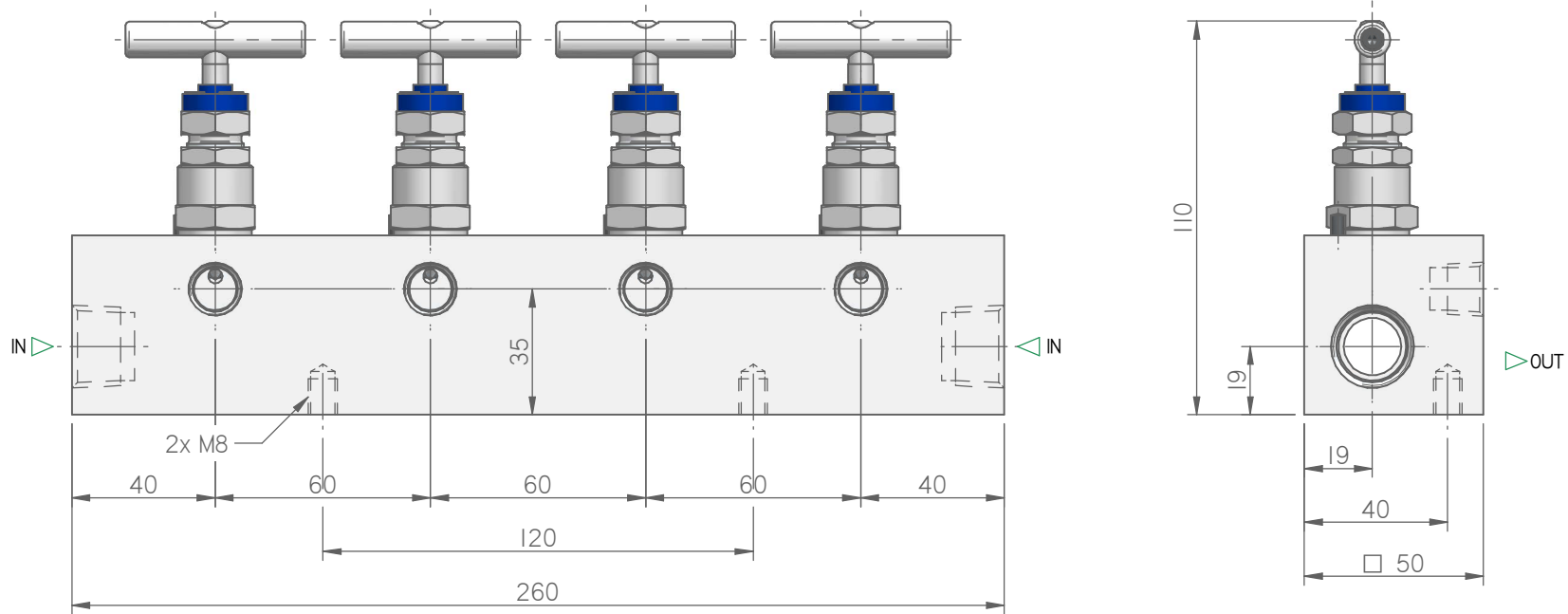

Bar stock distribution manifold. Straight line bonnet.

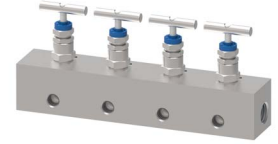
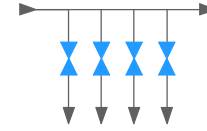

MODEL SELECTION

MODEL	MATERIAL	PACKING	IN	OUT	CODE	WEIGHT	NOTE
M92	AISI 316L	PTFE	1/2" NPT-F x2	1/4" NPT-F x4	M92-06STA8N4N	5,3 Kg	Packing material PTFE as standard max temperature 180 °C. The dimensions shown apply only to the illustrated valve – if you need the dimensions for your individual type or should you still not find your options at all please contact the factory.
	ASTM A105				M92-06ATA8N4N		
	F51				M92-06DTA8N4N		
	F55				M92-06ETA8N4N		
	ALLOY 400				M92-06FTA8N4N		
	C276				M92-06GTA8N4N		
	6MO				M92-06HTA8N4N		
I625	M92-06ITA8N4N						

I.T.E. s.r.l. COMMITS ITSELF TO CONSTANTLY IMPROVE ITS PRODUCTS AND THEREFORE IT RESERVES THE RIGHT TO MODIFY DATA, FEATURES WITHOUT NOTICE.

www.ite-srl.com

MODEL:
M92

DISTRIBUTION MANIFOLD



Bar stock distribution manifold. Straight line bonnet.

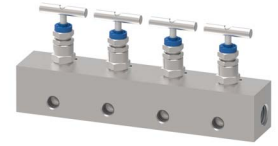
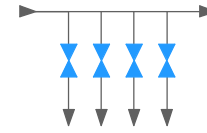

STANDARD FEATURES

PTFE and GRAPHOIL packing available for all valve types.

Wetted parts according to **NACE MR.0175/MR.0103** as standard.

Shell test and seat leakage test are performed according to **API 598** and **ASME B16.34** (1.5 of max rating pressure).

Certificate 3.1 certificate according to EN 10 204 on valve body material.

Valves and manifold are not supplied with plugs unless specified

MATERIAL

MATERIAL GROUP	I.T.E. DESIGNATION	ASTM	UNS
Stainless Steel	316/316L	316/316L	S31600
	6Mo		N08367
Ferritic Stainless Steel	Duplex	F51	S31803
	Superduplex	F55	S32750
Carbon Steel	LF2	LF2	
	A105	A105	
Alloy	Alloy 400		N04400
	Alloy C276		N10276
	Alloy 625		N06625
	Alloy 825		N08825
Titanium	Ti Gr.2		R50400

CONNECTIONS

NPT threads acc. to ASME B 1.20.1
 BSPT threads acc. to ISO 7/1
 BSPP threads acc. to ISO 228-1/ISO 1179-1
 Metric threads acc. to ISO 261
 G Threads acc. to ISO 228-1/EN 837-1
 Butt weld (male) acc. to ASME B16.9
 Socket Weld (female) acc. to ASME B16.11

CONNECTIONS

Maximum standard pressure up to 6.000 psig (414 barg).

Maximum optional pressure up to 10.000 psig (689 barg).

Temperature range -54°C to +530°C.

PTFE standard gland packing (Graphoil optional).

Max. temperature PTFE 260°C.

Max. temperature Graphoil 530°C.

Low operating torque.

Packing below threads to prevent lubricant washout.

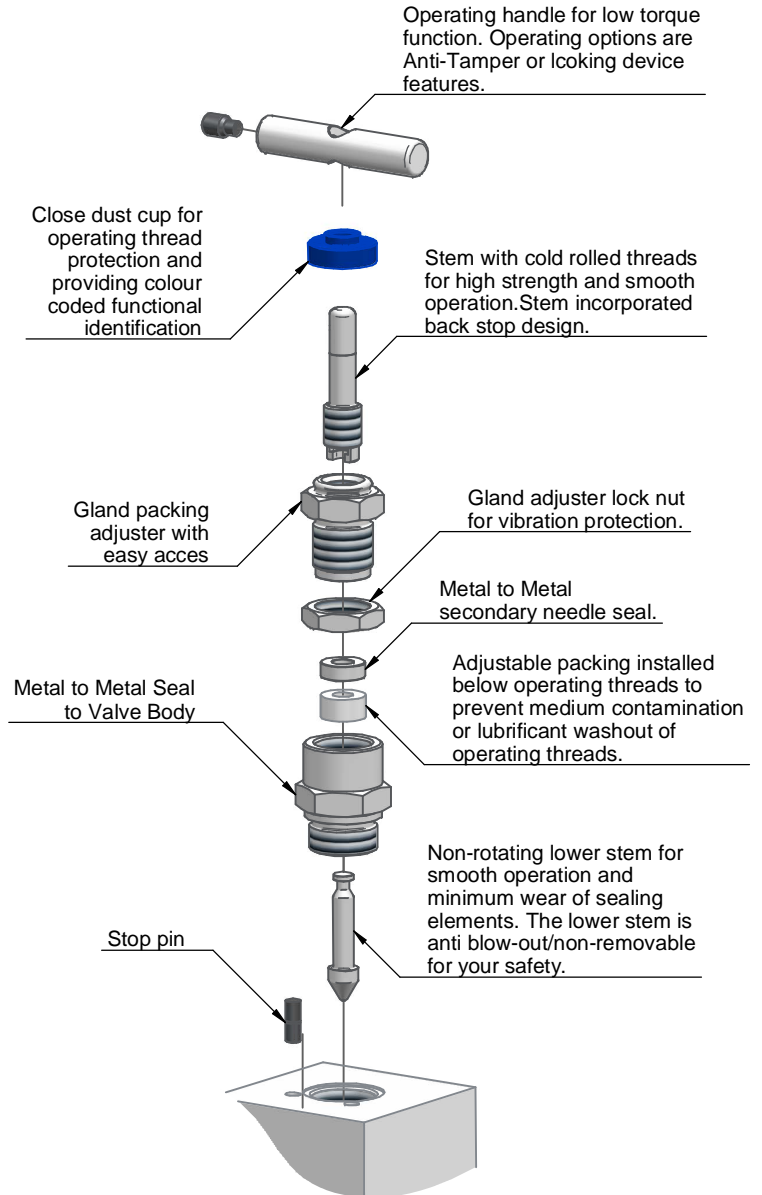

MODEL:
M92

DISTRIBUTION MANIFOLD



Bar stock distribution manifold. Straight line bonnet.

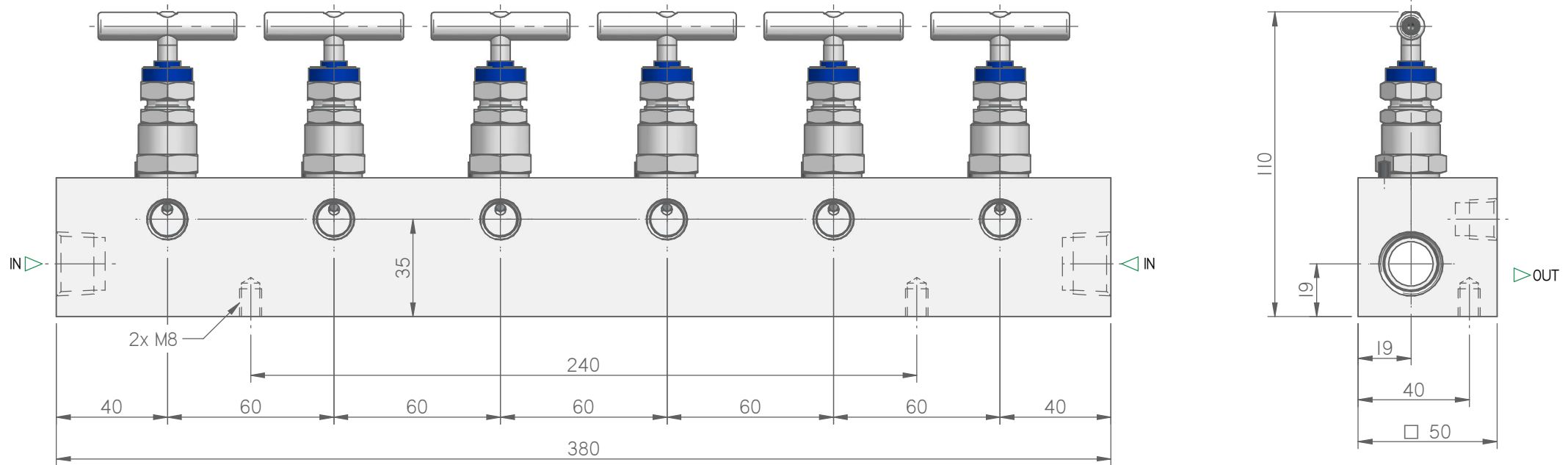
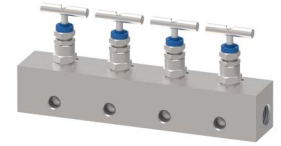
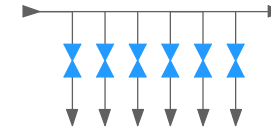

MODEL SELECTION

MODEL	MATERIAL	PACKING	IN	OUT	CODE	WEIGHT	NOTE
M92	AISI 316L	PTFE	1/2" NPT-F x2	1/4" NPT-F x6	M92-06STB8N4N	7,7 Kg	Packing material PTFE as standard max temperature 180 °C. The dimensions shown apply only to the illustrated valve – if you need the dimensions for your individual type or should you still not find your options at all please contact the factory.
	ASTM A105				M92-06ATB8N4N		
	F51				M92-06DTB8N4N		
	F55				M92-06ETB8N4N		
	ALLOY 400				M92-06FTB8N4N		
	C276				M92-06GTB8N4N		
	6MO				M92-06HTB8N4N		
I625	M92-06ITB8N4N						

I.T.E. s.r.l. COMMITS ITSELF TO CONSTANTLY IMPROVE ITS PRODUCTS AND THEREFORE IT RESERVES THE RIGHT TO MODIFY DATA, FEATURES WITHOUT NOTICE.

www.ite-srl.com

MODEL:
M92

DISTRIBUTION MANIFOLD



Bar stock distribution manifold. Straight line bonnet.

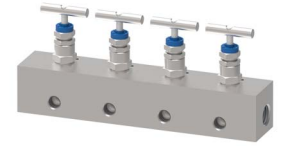
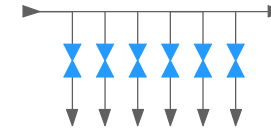

STANDARD FEATURES

PTFE and GRAPHOIL packing available for all valve types.

Wetted parts according to **NACE MR.0175/MR.0103** as standard.

Shell test and seat leakage test are performed according to **API 598** and **ASME B16.34** (1.5 of max rating pressure).

Certificate 3.1 certificate according to EN 10 204 on valve body material.

Valves and manifold are not supplied with plugs unless specified

MATERIAL

MATERIAL GROUP	I.T.E. DESIGNATION	ASTM	UNS
Stainless Steel	316/316L	316/316L	S31600
	6Mo		N08367
Ferritic Stainless Steel	Duplex	F51	S31803
	Superduplex	F55	S32750
Carbon Steel	LF2	LF2	
	A105	A105	
Alloy	Alloy 400		N04400
	Alloy C276		N10276
	Alloy 625		N06625
	Alloy 825		N08825
Titanium	Ti Gr.2		R50400

CONNECTIONS

NPT threads acc. to ASME B 1.20.1
 BSPT threads acc. to ISO 7/1
 BSPP threads acc. to ISO 228-1/ISO 1179-1
 Metric threads acc. to ISO 261
 G Threads acc. to ISO 228-1/EN 837-1
 Butt weld (male) acc. to ASME B16.9
 Socket Weld (female) acc. to ASME B16.11

CONNECTIONS

Maximum standard pressure up to 6.000 psig (414 barg).

Maximum optional pressure up to 10.000 psig (689 barg).

Temperature range -54°C to +530°C.

PTFE standard gland packing (Graphoil optional).

Max. temperature PTFE 260°C.

Max. temperature Graphoil 530°C.

Low operating torque.

Packing below threads to prevent lubricant washout.

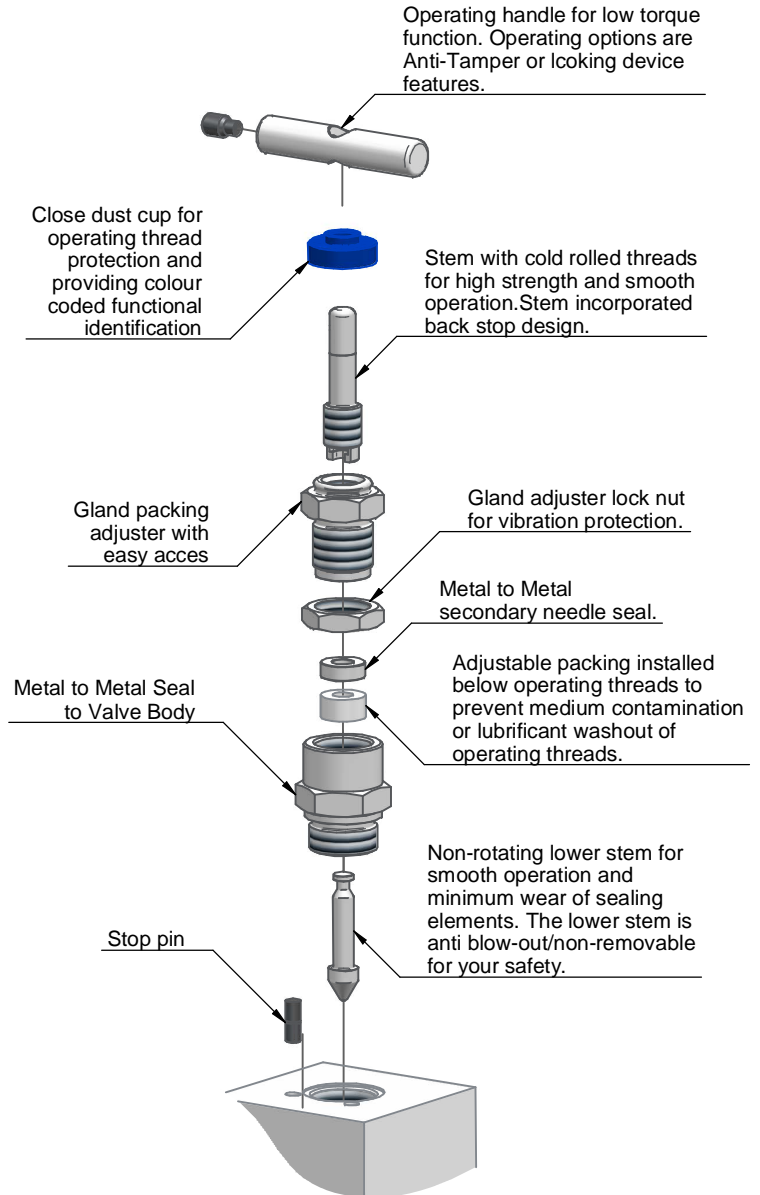

MODEL:
M92

DISTRIBUTION MANIFOLD



Bar stock distribution manifold. Straight line bonnet.

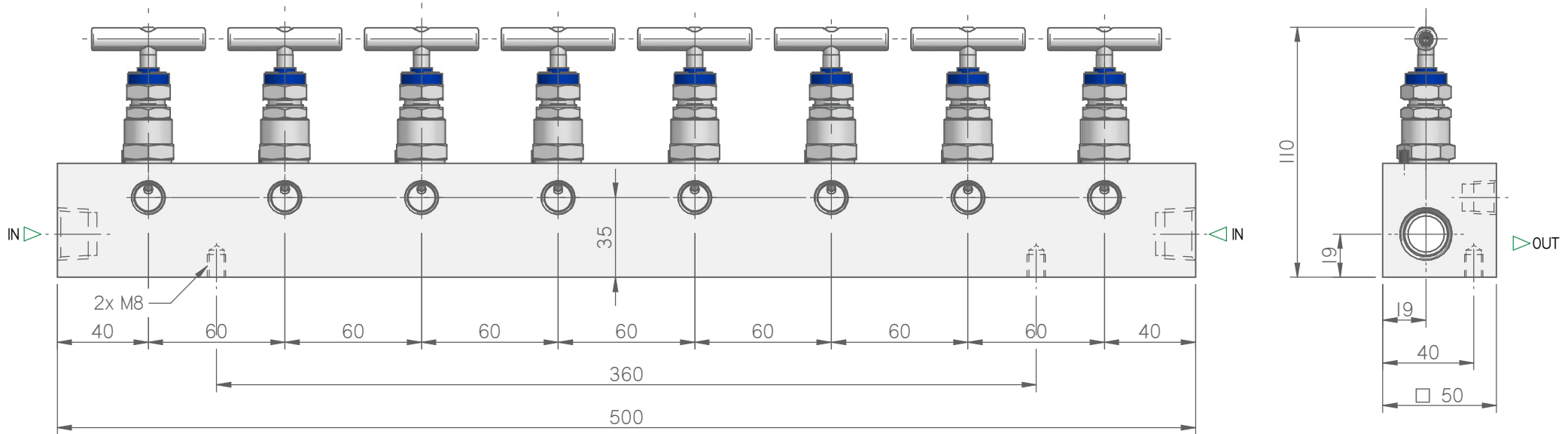
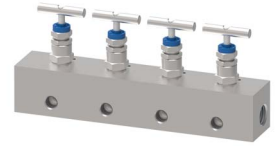
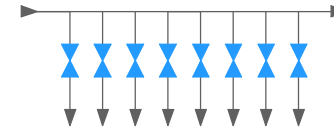

MODEL SELECTION

MODEL	MATERIAL	PACKING	IN	OUT	CODE	WEIGHT	NOTE
M92	AISI 316L	PTFE	1/2" NPT-F x2	1/4" NPT-F x8	M92-06STC8N4N	10,2 Kg	Packing material PTFE as standard max temperature 180 °C. The dimensions shown apply only to the illustrated valve – if you need the dimensions for your individual type or should you still not find your options at all please contact the factory.
	ASTM A105				M92-06ATC8N4N		
	F51				M92-06DTC8N4N		
	F55				M92-06ETC8N4N		
	ALLOY 400				M92-06FTC8N4N		
	C276				M92-06GTC8N4N		
	6MO				M92-06HTC8N4N		
	I625				M92-06ITC8N4N		

I.T.E. s.r.l. COMMITS ITSELF TO CONSTANTLY IMPROVE ITS PRODUCTS AND THEREFORE IT RESERVES THE RIGHT TO MODIFY DATA, FEATURES WITHOUT NOTICE.

www.ite-srl.com

MODEL:
M92

DISTRIBUTION MANIFOLD



Bar stock distribution manifold. Straight line bonnet.

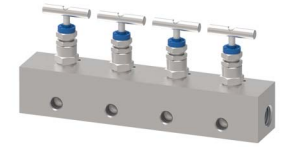
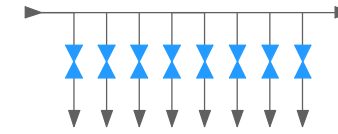

STANDARD FEATURES

PTFE and GRAPHOIL packing available for all valve types.

Wetted parts according to **NACE MR.0175/MR.0103** as standard.

Shell test and seat leakage test are performed according to **API 598** and **ASME B16.34** (1.5 of max rating pressure).

Certificate 3.1 certificate according to EN 10 204 on valve body material.

Valves and manifold are not supplied with plugs unless specified

MATERIAL

MATERIAL GROUP	I.T.E. DESIGNATION	ASTM	UNS
Stainless Steel	316/316L	316/316L	S31600
	6Mo		N08367
Ferritic Stainless Steel	Duplex	F51	S31803
	Superduplex	F55	S32750
Carbon Steel	LF2	LF2	
	A105	A105	
Alloy	Alloy 400		N04400
	Alloy C276		N10276
	Alloy 625		N06625
	Alloy 825		N08825
Titanium	Ti Gr.2		R50400

CONNECTIONS

NPT threads acc. to ASME B 1.20.1
 BSPT threads acc. to ISO 7/1
 BSPP threads acc. to ISO 228-1/ISO 1179-1
 Metric threads acc. to ISO 261
 G Threads acc. to ISO 228-1/EN 837-1
 Butt weld (male) acc. to ASME B16.9
 Socket Weld (female) acc. to ASME B16.11

CONNECTIONS

Maximum standard pressure up to 6.000 psig (414 barg).

Maximum optional pressure up to 10.000 psig (689 barg).

Temperature range -54°C to +530°C.

PTFE standard gland packing (Graphoil optional).

Max. temperature PTFE 260°C.

Max. temperature Graphoil 530°C.

Low operating torque.

Packing below threads to prevent lubricant washout.

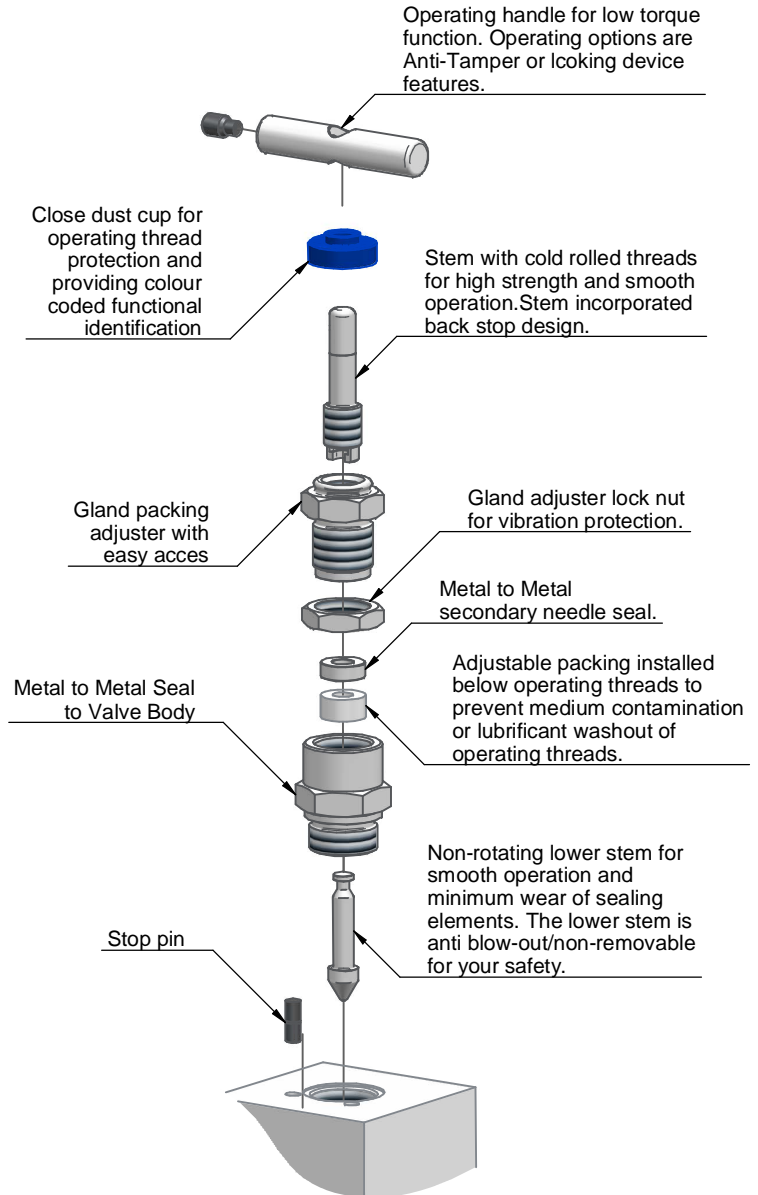

MODEL:
M92

DISTRIBUTION MANIFOLD



Bar stock distribution manifold. Straight line bonnet.

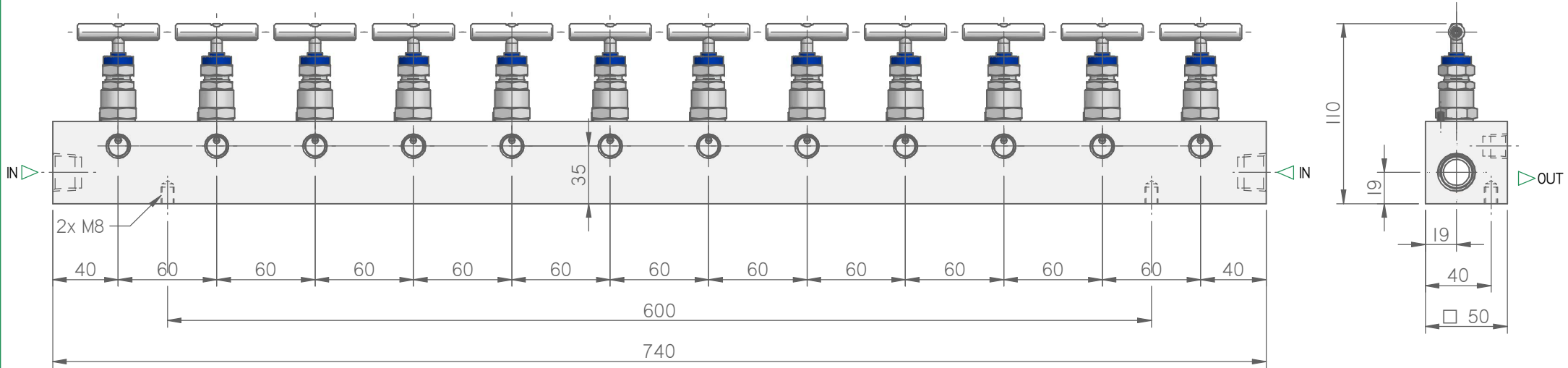
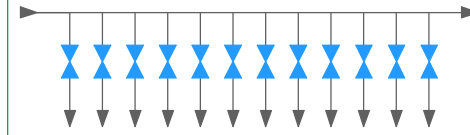

MODEL SELECTION

MODEL	MATERIAL	PACKING	IN	OUT	CODE	WEIGHT	NOTE
M92	AISI 316L	PTFE	1/2" NPT-F x2	1/4" NPT-F x12	M92-06STD8N4N	15,1 Kg	Packing material PTFE as standard max temperature 180 °C. The dimensions shown apply only to the illustrated valve – if you need the dimensions for your individual type or should you still not find your options at all please contact the factory.
	ASTM A105				M92-06ATD8N4N		
	F51				M92-06DTD8N4N		
	F55				M92-06ETD8N4N		
	ALLOY 400				M92-06FTD8N4N		
	C276				M92-06GTD8N4N		
	6MO				M92-06HTD8N4N		
I625	M92-06ITD8N4N						

I.T.E. s.r.l. COMMITS ITSELF TO CONSTANTLY IMPROVE ITS PRODUCTS AND THEREFORE IT RESERVES THE RIGHT TO MODIFY DATA, FEATURES WITHOUT NOTICE.

www.ite-srl.com

MODEL: M92

DISTRIBUTION MANIFOLD



Bar stock distribution manifold. Straight line bonnet.

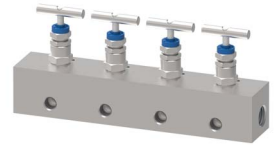
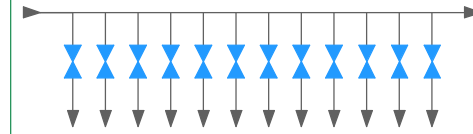

STANDARD FEATURES

PTFE and GRAPHOIL packing available for all valve types.

Wetted parts according to **NACE MR.0175/MR.0103** as standard.

Shell test and seat leakage test are performed according to **API 598** and **ASME B16.34** (1.5 of max rating pressure).

Certificate 3.1 certificate according to EN 10 204 on valve body material.

Valves and manifold are not supplied with plugs unless specified

MATERIAL

MATERIAL GROUP	I.T.E. DESIGNATION	ASTM	UNS
Stainless Steel	316/316L	316/316L	S31600
	6Mo		N08367
Ferritic Stainless Steel	Duplex	F51	S31803
	Superduplex	F55	S32750
Carbon Steel	LF2	LF2	
	A105	A105	
Alloy	Alloy 400		N04400
	Alloy C276		N10276
	Alloy 625		N06625
	Alloy 825		N08825
Titanium	Ti Gr.2		R50400

CONNECTIONS

NPT threads acc. to ASME B 1.20.1
 BSPT threads acc. to ISO 7/1
 BSPP threads acc. to ISO 228-1/ISO 1179-1
 Metric threads acc. to ISO 261
 G Threads acc. to ISO 228-1/EN 837-1
 Butt weld (male) acc. to ASME B16.9
 Socket Weld (female) acc. to ASME B16.11

CONNECTIONS

Maximum standard pressure up to 6.000 psig (414 barg).

Maximum optional pressure up to 10.000 psig (689 barg).

Temperature range -54°C to +530°C.

PTFE standard gland packing (Graphoil optional).

Max. temperature PTFE 260°C.

Max. temperature Graphoil 530°C.

Low operating torque.

Packing below threads to prevent lubricant washout.

